

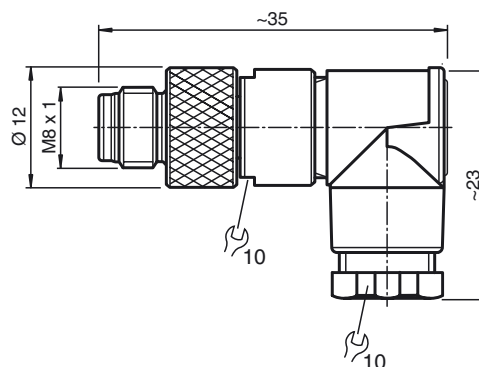

Dimensions



Model Number

V3S-WM

Field-attachable male connector, M8, 3-pin

Features

- Solder connection
- Metal locking
- Gold plated contacts

Technical data

General specifications

Number of pins	3
Connection 1	Male connector
Construction type 1	right angle
Threading 1	M8

Electrical specifications

Operating voltage	U_B	max. 60 V AC/DC
Operating current		max. 4 A
Volume resistance		< 3 m Ω

Ambient conditions

Ambient temperature	-40 ... 85 °C (-40 ... 185 °F)
Pollution Degree	3

Mechanical specifications

Protection degree	IP67
Connection	1 x M8 straight connector Solder connection for max. 0.25 mm ²

Material

Contacts	CuZn
Contact surface	Au
Connector	CuZn, nickel-plated
Body	PBT
Cable	
Sheath diameter	3.5 ... 5 mm
Flammability	
Contact material	UL 94 HB

Electrical connection

